

DS-1273ZJ-135B

Wall Mount



Feature

- Aluminum alloy with surface spray treatment
- The cable hole design facilitates the cable routing
- The cap design facilitates the installation

Dimension

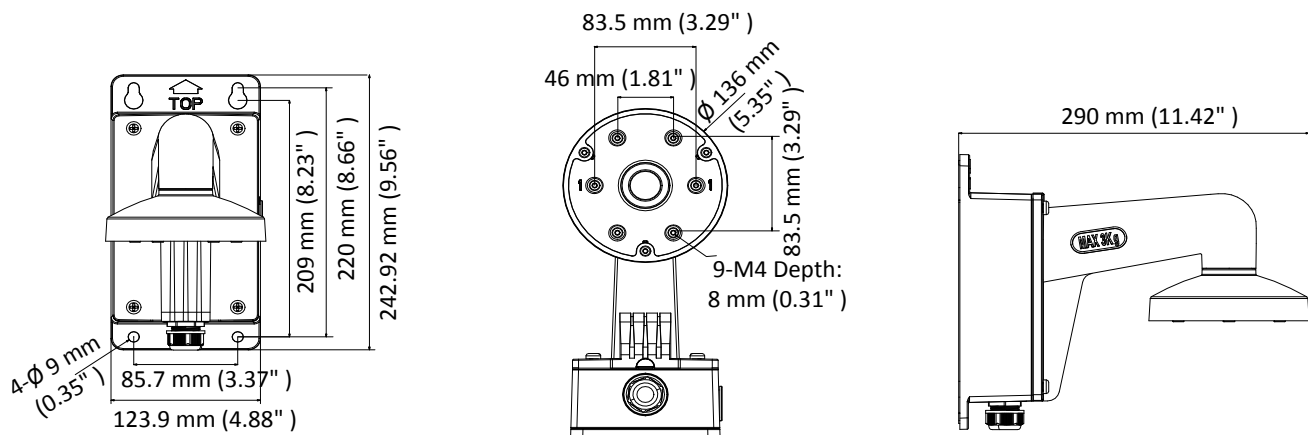

Available Model

DS-1273ZJ-135B

Parameter

Model	DS-1273ZJ-135B
Parameters	Wall Mount
Appearance	Hikvision White
Material	Aluminum Alloy
Dimension	Ø 136 mm × 242.92 mm × 290 mm (5.35" × 9.56" × 11.42")
Weight	1475 g (3.25 lb.)

Note

- The mount should be installed on the flat wall.
- The waterproof rubber is necessary for the outdoor application.
- The wall must be capable of supporting at least 3 times as much as the total weight of the camera, and the mount.
- The mount's maximum load capacity is 3 kg (6.6 lb.).